

Positioning University Nanotechnology Research for Commercial Success: The paper electronics

Rodrigo Martins, Elvira Fortunato,

**CENIMAT/I3N, Departamento de Ciência dos Materiais, Faculdade de Ciências e Tecnologia, Universidade Nova de Lisboa and CEMOP-UNINOVA,
2829-516 Caparica, Portugal**

***e-mail: ricardocosta@fct.unl.pt**

2008

September

- **Elvira Fortunato et al.**, *High-Performance Flexible Hybrid Field-Effect Transistors Based on Cellulose Fiber Paper*.
- (IEEE ELECTRON DEVICE LETTERS 29 (9) (2008) 988-990) . **PATENT**

2008

November

- **Rodrigo Martins et al.**, *Write-erase and read paper memory transistor*.
- (APPLIED PHYSICS LETTERS 93 (20) (2008) Article Number: 203501) . **PATENT**

2010

August

- **Isabel Ferreira et al.**, *Self-Rechargeable Paper Thin-Film Batteries: Performance and Applications* (ELECTROCHIMICA ACTA : 56 (3) (2011) 1099-1105) . **PATENT**

2011

August

- **Rodrigo Martins et al.**, *Complementary Metal Oxide Semiconductor Technology With and On Paper*
- (Advanced Materials, adma201102232) . . **PATENT**

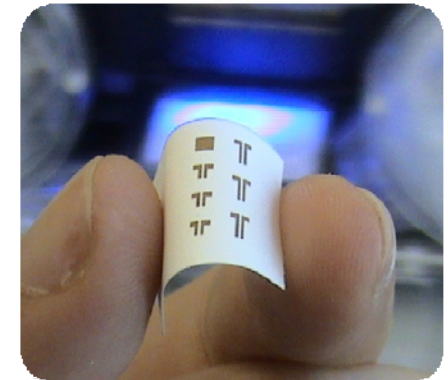

THE FIRST CMOS DEVICE On Paper



↓ IZO Gate
Deposition



↓ GIZO Channel
Deposition



↓ SnO Channel
Deposition



→ Ni/Au
Source / Drain
Deposition

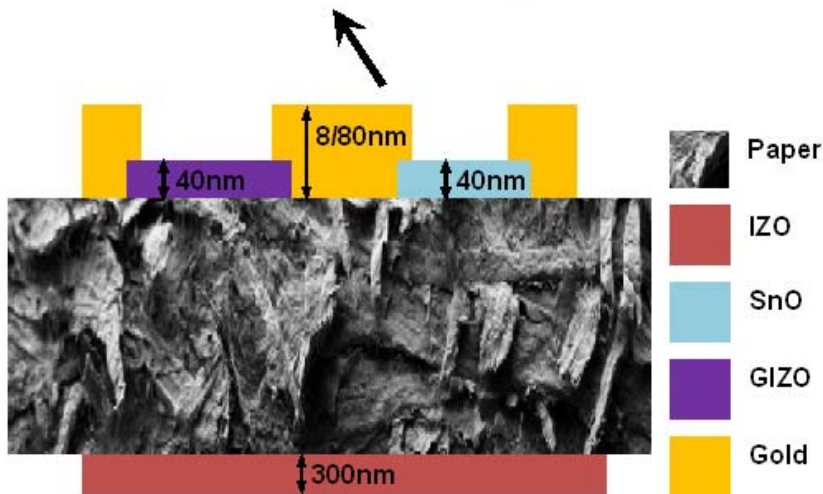

Why paper?



- ✓ Most common biopolymer;
- ✓ Low cost production,
- ✓ Flexible.



- ✓ Lightweight
- ✓ Flexible



- ✓ Low cost products



- ✓ Biodegradable and Recyclable

❖ New window of applications and disposable electronic.

Paper Properties

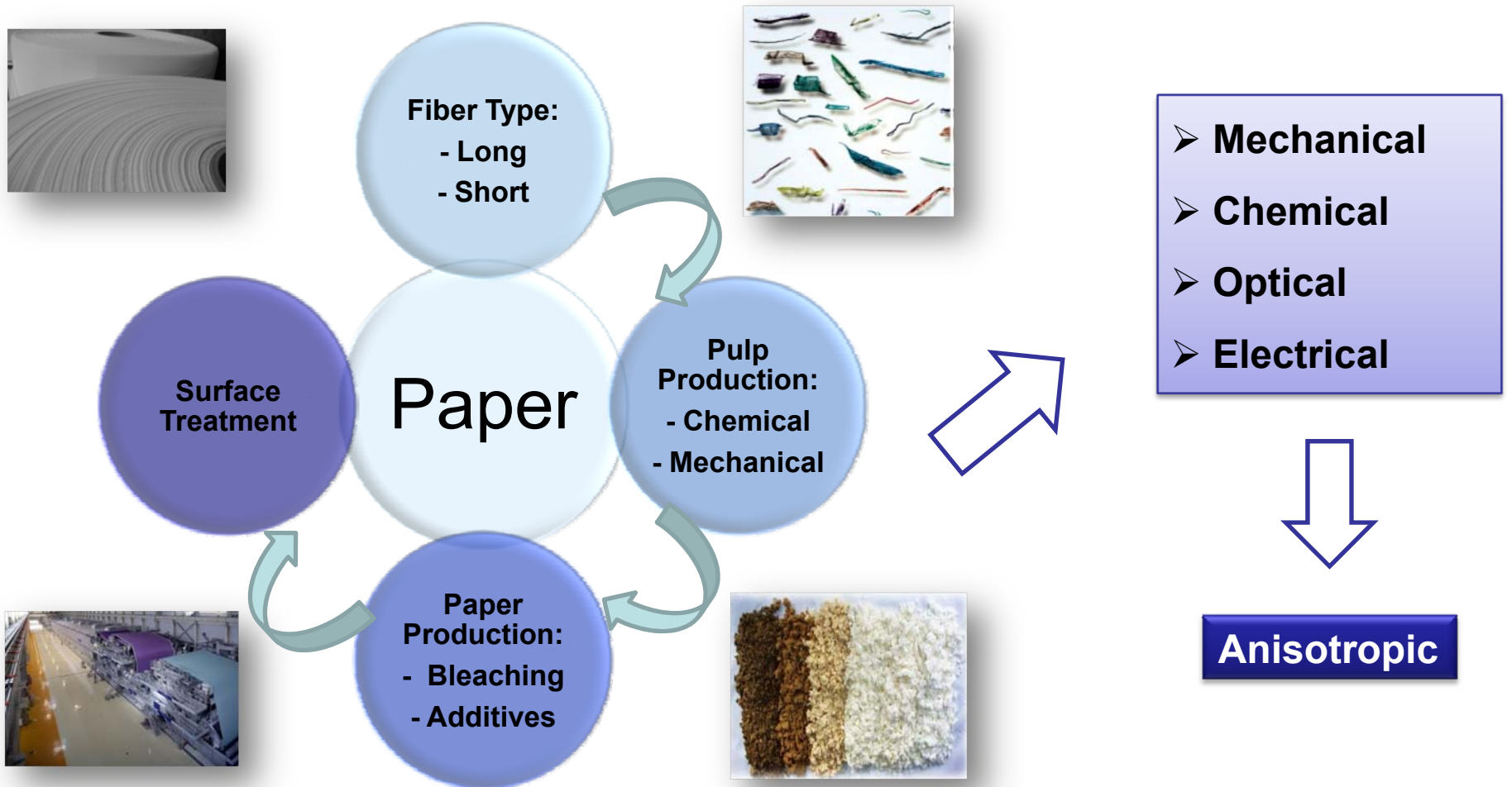

Paper Properties

MD – Machine Direction

Anisotropy

CD –
Cross
Machine
Direction

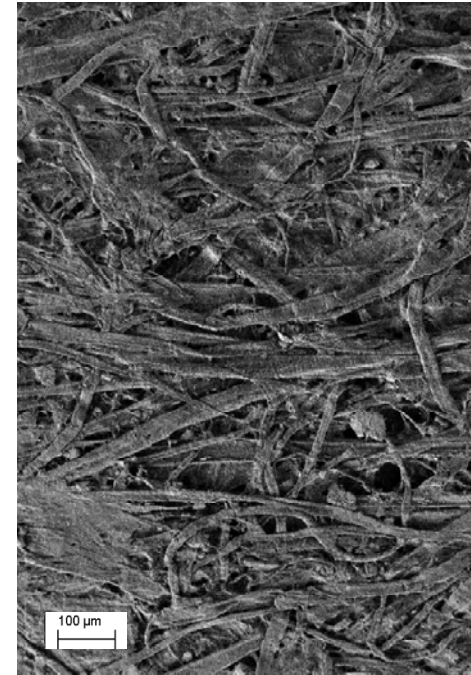

Example:
Mechanical strength **2x** higher in **MD**

mFO – Main Fiber Orientation

Objective: To make paper for electronics

Device Production

Structure

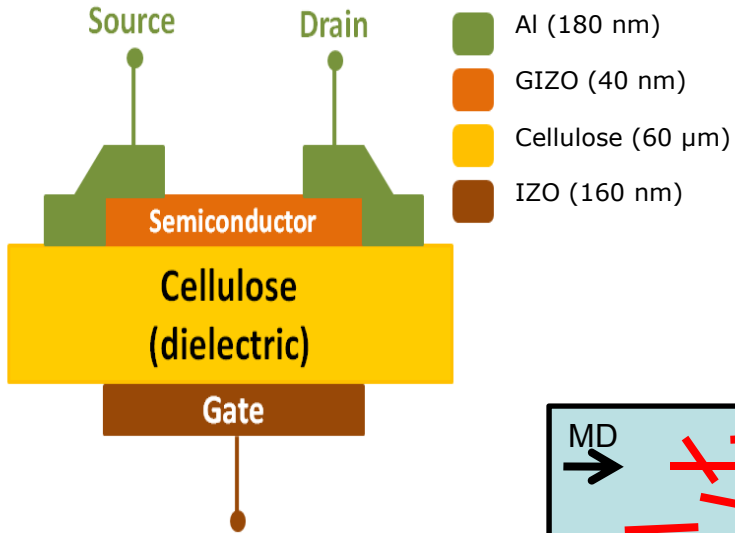

Process

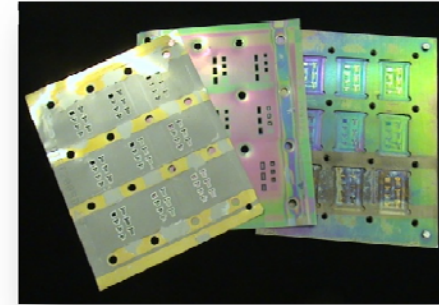

- RF magnetron sputtering
- E-beam thermal evaporation
- Shadow masks
- Annealing

Room Temperature

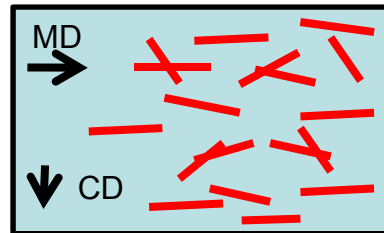

Market Perspectives

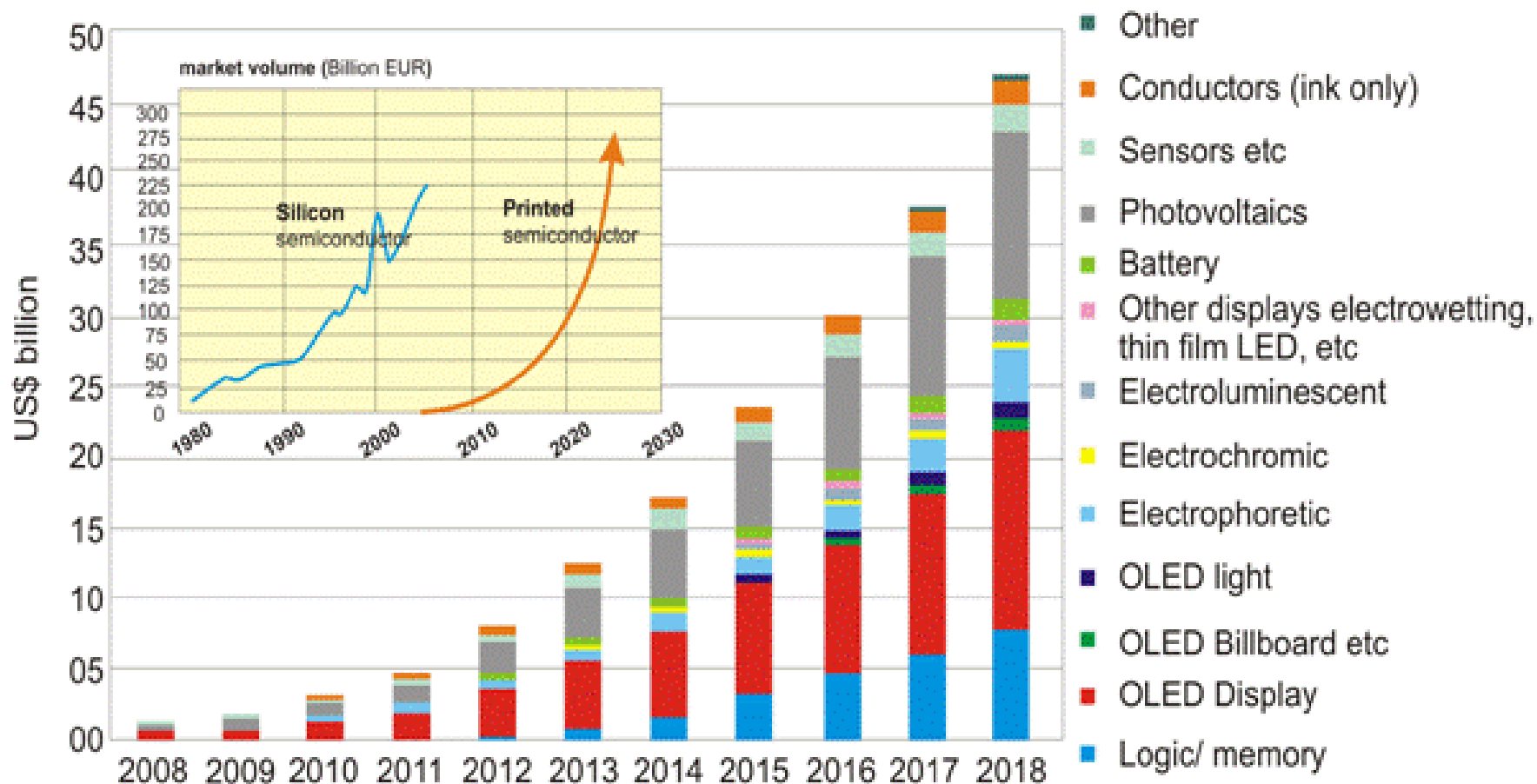

Patents

- R. Martins, E. Fortunato, I. Ferreira, A. Tagliaferro, “Development of a method to operate Tuneable Colour Sensors in order to achieve the maximum accuracy in detecting the colour of a light beam”, PAT 41249/09 (register 103936).
- R. Martins, E. Fortunato. Trade mark Paper – e: Green electronics for the future: EU (1025422-UE); Mexico; Canada; India; Brazil; Portugal; Australia; (JPO ref. n°2010-350483); (EST/1025422-N).; Switzerland; China; South Korea; Russia; USA.
 - R. Martins E. Fortunato, , P. Baptista, “Detection and quantification system of biological matter constituted by one or more optical sensors and one or more light sources, associated process and respective uses”: EU (PPE 40002/09); South Africa (PTI-ZA.40004/09); Portugal (PAT 103951); USA (PTI-US 40003/09); Brazil (PTI-BR 40005/09).
 - R. Martins, E. Fortunato, “Fabrication Process of Covalent Semiconductor/- Ionic Oxide Semiconductor Heterojunctions and their applications in the Optoelectronics” PAT 40111/09 (register 103670), conceived data: 08-05-2009.
 - R. Martins, E. Fortunato, “Solid State Time Meters and corresponding control system and Fabrication Process”. PAT 40301/09 (register 103671), conceived: 02/04/2009.
 - D. Kang, I. Song, E. Fortunato, R. Martins, international patent “Thin Film Transistor and Method of Manufacturing the Same” n° 2557-000845US (2007); Korea KR2008277663 (register:103936) conceived: 13/11/2008. Owner: Samsung.
 - R. Martins and E. Fortunato, “Electronic Semiconductor devices based on copper nickel and Gallium-Tin-Zinc-Copper-Titanium p and n-type oxides, their applications and corresponding fab manuf. process: EU (PTI41098/2009); PCT/PT2007/ 000008; (PTI-BR 40652/09); (PTI-AU 40653/09); (PTI-CA 40654/09); (PTI-JP 40655/09); (PTI-US 40656/09).
 - E. Fortunato, R. Martins, “Use of cellulose and bio-organic based paper simultaneously as physical support and dielectric component in field effect electronic and optoelectronic based devices”: EU (PPE 42404/10); (PAT 35452/09); (PTI-MX 42405/10); (PTI-BR 42407/10); (PTI-US 42408/10); (PTI-CA 42409/10); (PTI-RU 42410/10); (PTI-IN 42411/10); (PTI-CN 42412/10); (PTI-JP 42413/10); (PTI-KR 42414/10); (PTI-AU 42415/10).

- E. Fortunato, R. Martins, L. Pereira, P. Barquinha and N. Correia, “Use of cellulose and bio-organic based fibbers simultaneously as physical support and charged memory component in field effect electronic devices”: EU (PPE 42416/10); (PAT 40050/09); (PTI-MX 42418/1); (PTI-BR 42419/1); (PTI-US 42420/1); (PTI-CA 42421/1); Russia (PTI-RU 42422/1); (PTI-IN 42423/1); (PTI-CN 42424/1); (PTI-JP 42425/1); (PTI-KR 42426/1); (PTI-AU 42427/1).
- E. Fortunato; C. Costa, I. Ferreira, R. Martins, I. Henriques, “Functionalization of the paper simultaneously as substrate electrochromic material, electrolyte material and counter electrode for the creation of self sustainable electrochromic and energy store devices., PAT 1303/2010, pending. Owners: FCT/UNL (Portugal); YDreams (Portugal)
- E. Fortunato, R. Martins, A. Câmara, “Processing of Electrical and Electronic devices in cellulose based substrates” PAT 103951, 2008, PPI 103951, pending. Owners: FCT/UNL (Portugal); YDreams (Portugal)
- R. Martins, E. Fortunato, Method for the manufacture and creation of electrochromic thin film transistors with lateral or vertical structure using functionalized or non-functionalized vitroc ceramic, polymeric, metallic, or natural, synthetic or mixed cellulose paper substrates: UE (PCT/IB2009/054425); (PAT 40425/09); PPI 40992/09.
- I. Ferreira, A. Baptista, B. Brás, J. P. Borges, E. Fortunato, R. Martins, devices for the energy production or store based on cellulose fibbers and thin film oxide electrodes, PAT 40718/09; EU PPI 40993/09; 28619/ PCT/IB2009/054423.
- E. Fortunato, R. Martins, R. Barros, P. Barquinha, V. Figueiredo, Sang-Hee Ko Park, Chi-Sun Hwang, Process of creation and use of copper oxide with embedded metal copper cations, tin oxide with embedded metal tin cations, copper tin oxide alloys with embedded copper tin metal alloys and nikel oxide embedded with Ni and tin metal cations as p-type oxides for electronics applications such as thin film transistors and complementary metal oxide semiconductor devices: PTI-KR4233/2010; UE PAT 410981/2010; PT 41098. Pending. Owners: UNL (Portugal), ETRI (Korea).
- R. Martins, I. Ferreira, E. Fortunato, H. Águas, L. Gomes, V. Teixeira Tiles, Mosaics and ceramic coatings as photovoltaic devices: Solar Tiles. PAT 41758/10. Owners: UNL, Revigrés, CTCV, ADENE, INETI, Un Minho, Dominó, LNG, De Viris.
- R. Martins, E. Fortunato, L. Pereira, P. Barquinha, D. Kuscer, M. Kosec, J. Holc, S. Drnovšek. Amorphous multicomponent dielectric based on the mixture of high band gap and k dielectrics, respective devices and manufacture, PAT42360/10; PCT/PT2010/000037; PPI 42360/10. Pending. Owners: FCT/UNL (Pt); Un. Barcelona (Sp); JSI (SI)
- R. Martins, P. Wocik, E. Fortunato, “Method for efficiency improvement of mesoscopic optoelectronic devices as solar cells and photo sensors using 3D arrays micropillars deposited from suspension via inkjet printing”, PAT 42526/10, pending.

How to Exploit it?

Research: Converts € into Results

Innovation: Converts Results into €

Insight + Invention + Implementation

Entrepreneurship is the DNA, the Key!

But to succeed, entrepreneurs need dedicated help from a well-organized machinery

How to Bridge The Gap??

- Bridge construction

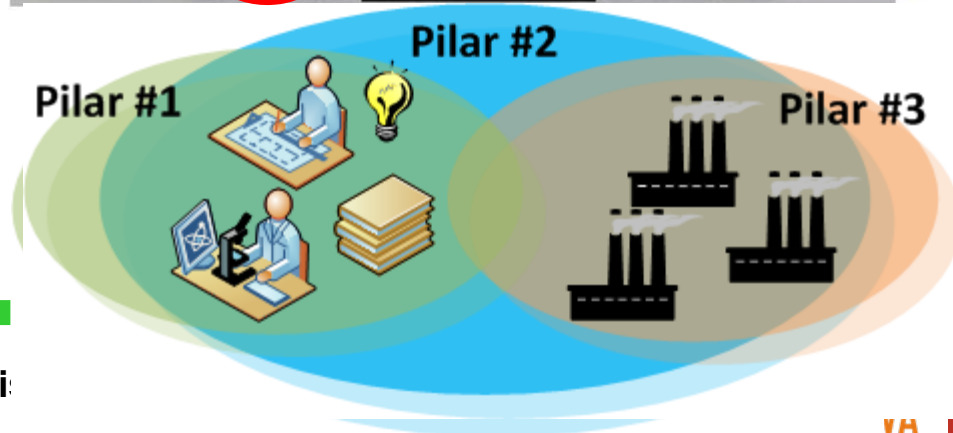
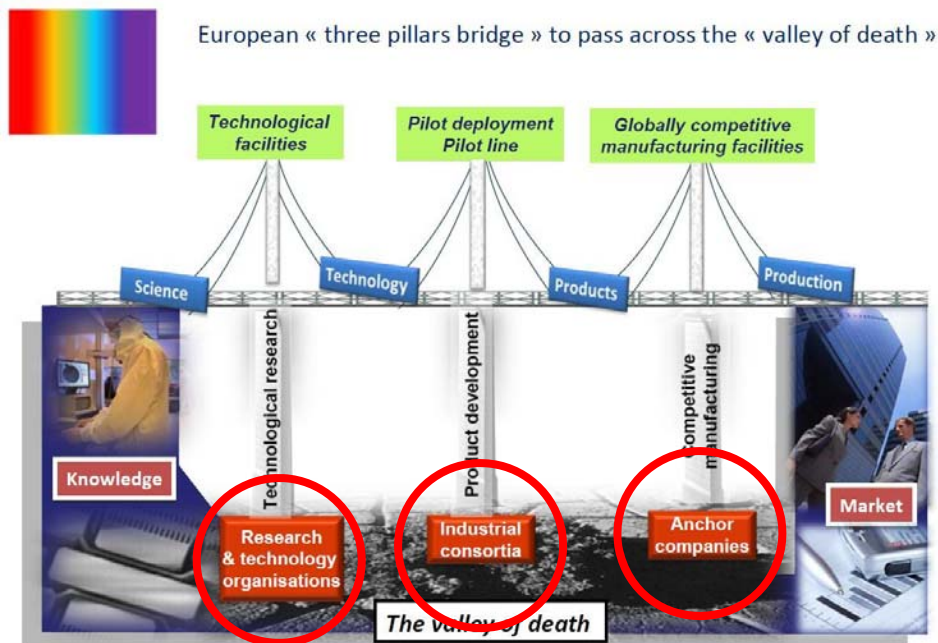

How we are doing?

To keep strategic cooperation with Companies:

- ✓ **SAMSUNG: Transparent Electronics** (sharing a patent)
- ✓ **Oxide Electronics: EU Project with Phillips et al + HP** (patent on dielectrics) + **Saint Gobain** (novel oxides)
- ✓ **ETRI/LG: CMOS Oxides** (Sharing a patent recently submitted)
- ✓ **Fuji/Japan: Transparent conductive oxides for solar cells;**
- ✓ **Solar Tiles: Patent: Portuguese consortium leadered by REVIGRÉS**
- ✓ **Electrochomic Transistors: EU Project shared with FIAT** (patent)
- ✓ **Paper electronics: 3 EU Projects and direct contract with SUZANO, Brasil**
- ✓ **Thermocromic materials: Contract with THALES within EU Project**
- ✓ **INK JET Printing: EU Project with EU leader companies**

Acknowledgments

Electronic and Optoelectronic Materials Group – September 2011



“INVISIBLE”
(ERC-2008-AdG 228144)



FCT Fundação para a Ciência e a Tecnologia
MINISTÉRIO DA CIÊNCIA, TECNOLOGIA E ENSINO SUPERIOR

Thank you for
your attention